

TOWN OF GLASTONBURY

INVITATION TO BID

<u>BID #</u>	<u>ITEM</u>	<u>DATE & TIME REQUIRED</u>
GL-2013-25	Annual Sidewalk Program	March 12, 2013 @ 11:00 A.M.

The Town of Glastonbury will receive Sealed Bids, in duplicate, for the repair and replacement of concrete sidewalks at various locations throughout the town. Bids will be received only at the Office of the Purchasing Agent, Town Hall (second level), 2155 Main Street, Glastonbury, CT 06033, Attention: Mary F. Visone, Purchasing Agent, until March 12, 2013 at 11:00 A.M. (local time), at which time they will be publicly opened and read aloud. No late bids will be accepted.

The Town reserves the right to waive informalities or reject any part of, or the entire bid, when said action is deemed to be in the best interests of the Town.

Bid Forms may be obtained from the Town's website at www.glastonbury-ct.gov or at the Office of the Purchasing Agent, Town Hall, 2155 Main Street, Glastonbury, Connecticut 06033, (second level).

The Town of Glastonbury is an Affirmative Action/Equal Opportunity Employer. Minority / Women / Disadvantaged Business Enterprises are encouraged to bid.

Mary F. Visone
Purchasing Agent

TABLE OF CONTENTS

SECTION

[INFORMATION FOR BIDDERS](#)

IB

[GENERAL CONSTRUCTION SPECIFICATIONS](#)

GCS

[SPECIAL CONDITIONS](#)

SC

[DETAILED CONSTRUCTION SPECIFICATIONS](#)

DCS

[BID PROPOSAL](#)

BP

**ANNUAL SIDEWALK PROGRAM
INFORMATION FOR BIDDERS**

BID #GL-2013-25

1. Sealed bids (**one original and one copy**) on the attached Bid Forms will be received at the Office of the Purchasing Agent, Town Hall, 2155 Main Street, Glastonbury, Connecticut 06033 (second level). At the designated time of opening, they will be publicly opened, read, recorded and placed on file.
2. Whenever it is deemed to be in the best interest of the Town, the Town Manager, Purchasing Agent or designated representative shall waive informalities in any and all bids. The right is reserved to reject any bid, or any part of any bid, when such action is deemed to be in the best interest of the Town of Glastonbury.
3. The award will be made as indicated in Section 02.00 of the Special Conditions.
4. Bids will be carefully evaluated as to conformance with stated specifications.
5. The envelope enclosing your bid should be clearly marked by bid number, time of bid opening, and date.
6. Specifications must be submitted complete in every detail and, when requested, samples shall be provided. If a bid involves any exception from stated specifications, they must be clearly noted as exceptions, underlined, and attached to the bid.
7. The Bid Documents contain the provisions required for the requested item. Information obtained from an officer, agent, or employee of the Town or any other person shall not affect the risks or obligations assumed by the Bidder or relieve him/her from fulfilling any of the conditions of the bid.
8. Each Bidder is held responsible for the examination and/or to have acquainted themselves with any conditions at the job site which would affect their work before submitting a bid. Failure to meet this criteria shall not relieve the Bidder of the responsibility of completing the bid without extra cost to the Town of Glastonbury.
9. Any bid may be withdrawn prior to the above-scheduled time for the opening of bids or authorized postponement thereof. Any bid received after the time and date specified shall not be considered. No Bidder may withdraw a bid within sixty (60) days after the actual date of the opening thereof. Should there be reasons why a bid cannot be awarded within the specified period, the time may be extended by mutual agreement between the Town and the Bidder.
10. Each bid must be accompanied by a bid bond payable to the Town for ten percent (10%) of the total amount of the bid. The bid bond of the successful Bidder will be retained until the payment bond and performance bond have been executed and approved, after which it will be returned. A certified check may be used in lieu of a bid bond. The Town of Glastonbury will not be liable for the accrual of any interest on any certified check submitted. Cashier's checks will not be accepted.
11. A Five Thousand Dollar (\$5,000.00) Performance Bond is required of the successful Bidder. This bond will be returned upon successful completion of the required work within the time periods as set forth in the Bid Proposal.
12. The Bidder agrees and warrants that in the submission of this sealed Bid, they will not discriminate or permit discrimination against any person or group of persons on the grounds of race, color, religion, national origin, sex, or physical disability including, but not limited to blindness, unless it is shown by such Bidder that such disability prevents performance of that which must be done to successfully fulfill the terms of this sealed Bid or in any manner which is prohibited by the laws of the United States or the State of

Connecticut: and further agrees to provide the Human Relations Commission with such information requested by the Commission concerning the employment practices and procedures of the Bidder. An Affirmative Action Statement will be required by the successful Bidder.

13. Bidder agrees to comply with all of the latest Federal and State Safety Standards and Regulations and certifies that all work required in this bid will conform to and comply with said standards and regulations. Bidder further agrees to indemnify and hold harmless the Town for all damages assessed against the Town as a result of Bidder's failure to comply with said standards and/or regulations.
14. All correspondence regarding any purchase made by the Town of Glastonbury shall reference the Town's purchase order number. Each shipping container shall clearly indicate both Town purchase order number and item number.
15. Bidder is required to review the Town of Glastonbury Code of Ethics adopted July 8th, 2003 and effective August 1, 2003. Bidder shall acknowledge that they have reviewed the document in the area provided on the bid/proposal response page (BP). The selected Bidder will also be required to complete and sign an Acknowledgement Form prior to award. The Code of Ethics and the Consultant Acknowledgement Form can be accessed at the Town of Glastonbury website at www.glastonbury-ct.gov. Upon entering the website click on **Bids & RFPs**, which will bring you to the links for the **Code of Ethics** and the **Consultant Acknowledgement Form**. If the Bidder does not have access to the internet a copy of these documents can be obtained through the Purchasing Department at the address listed within this bid.
16. **Non-Resident Contractors:**

The Town is required to report names of non-resident (out-of-State) contractors to the State of Connecticut, Department of Revenue Services (DRS) to ensure that Employment Taxes and other applicable taxes are being paid by Contractors. **Upon award, all non-resident contractors must furnish a five percent (5%) sales tax guarantee bond (State Form AU-766) or a cash bond for five percent (5%) of the total contract price (State Form AU-72) to DRS even though this project is exempt from most sales and use taxes.**

See State Notice to Non-Resident Contractors SN 2005 (12). If the above bond is not provided, the Town is required to withhold five percent (5%) from the contractor's payments and forward it to the State DRS.

The contractor must promptly furnish to the Town a copy of the **Certificate of Compliance** issued by the State DRS.
17. Bidder shall include on a sheet(s) attached to its proposal a complete disclosure of all past and pending mediation, arbitration and litigation cases that the Bidder or its principals (regardless of their place of employment) have been involved in for the most recent five years. Please include a statement of the issues in dispute and their resolution. Acceptability of Bidder based upon this disclosure shall lie solely with the Town.
18. Bidder or its principals, regardless of their place of employment, shall not have been convicted of, nor entered any plea of guilty, or nolo contendere, or otherwise have been found civilly liable or criminally responsible for any criminal offense or civil action. Bidder shall not be in violation of any State or local ethics standards or other offenses arising out

of the submission of bids or proposals, or performance of work on public works projects or contracts.

19. It is the responsibility of the bidder to check the Town's website before submitting bid for addendums posted prior to bid opening.
20. Each bid shall also include a description of three (3) projects completed by the bidder with references to demonstrate successful experience with similar projects.

IMPORTANT: Failure to comply with general rules may result in disqualification of the Bidder.

NOTE: Any technical questions regarding this bid shall be made in writing (email acceptable) and directed to Stephen Braun, Assistant Town Engineer, 2155 Main Street, PO Box 6523, Glastonbury, CT 06033; stephen.braun@glastonbury-ct.gov. Telephone (860) 652-7743 between the hours of 8:00 a.m. – 4:30 p.m. For administrative questions concerning this bid/proposal, please contact Mary F. Visone, Purchasing Agent, at (860) 652-7588. All questions, answers, and/or addenda, as applicable will be posted on the Town's website at www.glastonbury-ct.gov. (Upon entering the website click on Bids & RFP's). The request must be received at least five (5) business days prior to the advertised response deadline. **It is the respondent's responsibility to check the website for addenda prior to submission of any bid/proposal.**

01.00 WORKMANSHIP, MATERIALS AND EMPLOYEES

- 01.01 Wherever in this contract the word "Engineer" is used, it shall be understood as referring to the Town Engineer/Manager of Physical Services of the Town of Glastonbury acting personally or through any assistants duly authorized.
- 01.02 The entire work described herein shall be completed in accordance with the plans and specifications to the full intent and meaning of the same. Unless otherwise specified, all materials incorporated in the permanent work shall be new, and both workmanship and material shall be of good quality. The Contractor shall, if required, furnish satisfactory evidence as to the kind and quality of materials.
- 01.03 The wording "furnish", "install", "construct", "furnish and install", or any similar terms, unless specifically noted to the contrary, shall include all labor, materials, water, tools, equipment, light, power, transportation, and any other services required for the completion of the work.
- 01.04 The Contractor shall at all times enforce strict discipline and good order among his employees, and shall seek to avoid employing on the work any unfit person or anyone not skilled in the work assigned to him.

02.00 SUPERINTENDENT

- 02.01 If so deemed advisable by the Engineer, the Contractor shall keep on the work during its progress, a competent Superintendent. The Superintendent shall be acceptable to the Engineer and shall represent the absent Contractor. All directions given to the Superintendent shall be binding as if given to the Contractor.

03.00 PRECONSTRUCTION MEETING

- 03.01 A Preconstruction Meeting will be held with the Engineer, Contractor, and any private utility company prior to commencing any work. It will be the obligation of the Contractor to arrange such a meeting.

04.00 INSURANCE

- 04.01 The Contractor shall, at its own expense and cost, obtain and keep in force during the entire duration of the Project or Work the following insurance coverage covering the Contractor and all of its agents, employees and sub-contractors and other providers of services and shall name the **Town and the Board of Education, its employees and agents as an Additional Insured** on a primary and non-contributory basis to the Bidders Commercial General Liability and Automobile Liability policies. **These requirements shall be clearly stated in the remarks section on the Contractors Certificate of Insurance.** Insurance shall be written with insurance carriers approved in the State of Connecticut and with a minimum Best's Rating of A-. In addition, all carriers are subject to approval by the Town. Minimum Limits and requirements are stated below:

- a. Worker's Compensation Insurance:
- Statutory Coverage
 - Employer's Liability
 - \$100,000 each accident/\$500,000 disease-policy limit/\$100,000 disease each employee
- b. Commercial General Liability:
- Including Premises and Operations, Products and Completed Operations, Personal and Advertising Injury, Contractual Liability and Independent Contractors
 - Limits of Liability for Bodily Injury and Property Damage
Each Occurrence: \$1,000,000
Aggregate: \$2,000,000
(The Aggregate Limit shall apply separately to each job.)
 - A Waiver of Subrogation shall be provided.
- c. Automobile Insurance:
- Including all owned, hired, borrowed, and non-owned vehicles
 - Limit of Liability for Bodily Injury and Property Damage
Per Accident: \$1,000,000

04.02 The Contractor shall direct its Insurer to provide a Certificate of Insurance to the Town before any work is performed. The Contractor shall be responsible to notify the Town 30 days in advance with written notice of cancellation or non-renewal. The Certificate shall evidence all required coverage including the Additional Insured on the General Liability and Auto Liability policies and Waiver of Subrogation on the General Liability policy. The Contractor shall provide the Town copies of any such insurance policies upon request.

04.03 INDEMNIFICATION: To the fullest extent permitted by law, the Contractor shall indemnify and hold harmless the Town and the Board of Education, its consultants, agents, and employees from and against all claims, damages, losses and expenses, direct, indirect or consequential (including but not limited to fees and charges of engineers, attorneys and other professionals and court and arbitration costs) to the extent arising out of or resulting from the performance of the Contractor's work, provided that such claim, damage, loss or expense is caused in whole or in part by any negligent act or omission by the Contractor, or breach of its obligations herein or by any person or organization directly or indirectly employed or engaged by the Contractor to perform or furnish either of the services, or anyone for whose acts the Contractor may be liable.

05.00 PERMITS

05.01 All permits, licenses, and fees required for the performance of the Contract work, except for local requirements, shall be secured and paid for by the Contractor. Local fees shall be waived. Property and easements for permanent changes and temporary construction easements in existing facilities shall be secured and paid for by the Town.

05.02 The Contractor shall make arrangements with the adjacent property owners for such trespass as he may reasonably anticipate in the performance of the work. All such arrangements shall be reported in writing to the Engineer.

06.00 PROPERTY ACCESS

06.01 The Contractor shall take all proper precautions to protect from injury or unnecessary interference, and provide proper means of access to abutting property where the existing access is cut off by the Contractor.

06.02 The Contractor shall take all proper precautions to protect persons from injury or unnecessary inconvenience and leave an unobstructed way along the public and private places for travelers, vehicles, and access to hydrants.

07.00 PROTECTION OF THE PUBLIC AND OF WORK AND PROPERTY

07.01 The Contractor shall continuously maintain adequate protection of all work from damage, and shall take all reasonable precautions to protect the Town from injury or loss arising in connection with the Contract.

07.02 The Contractor shall make good any damage, injury, or loss of his work and to the property of the Town resulting from lack of reasonable protective precautions, except such as may be due to errors in the Contract Documents, or caused by agents or employees of the Town.

07.03 The Contractor shall adequately protect adjacent private and public property as provided by law and the Contract Documents.

08.00 TRAFFIC AND SAFETY

08.01 The Contractor shall provide, in accordance with the "Manual on Uniform Traffic Control Devices" (MUTCD) as published by the Federal Highway Administration, such barricades, signs, warnings, and flagmen, and shall conduct his work in such a manner so that hazards to vehicular and pedestrian traffic are at a minimum. If, in the opinion of the Engineer, additional precautions or measures should be taken in the interest of public safety, the Contractor shall so comply.

08.02 If the Contractor finds it necessary to close a portion of the road to vehicular traffic, the approval of the Engineer and the Glastonbury Police Chief shall be obtained. The Contractor shall notify the Fire Department and any other concerned agencies of such road closings. Access shall be provided at all times to fire hydrants and precautions shall be taken to prevent freezing of any exposed or partially uncovered water lines.

09.00 EXISTING IMPROVEMENTS

09.01 The Contractor shall conduct his work so as to minimize damage to existing improvements. Except where specifically stated otherwise in the specifications or drawings, it will be the responsibility of the Contractor to restore to their original condition, as nearly as practical, all improvements on public property. Any such damage resulting from the operation of the vendor or his agent in completing the work required shall be the responsibility of the vendor. Restoration shall be made to the full satisfaction of, and without cost to, the Town of Glastonbury.

09.02 The Contractor shall give ample notice to the various utilities so that existing lines can be marked in the field and adjustments made. The Contractor shall cooperate fully with the various utilities and shall plan his work so that the least interference is caused for all parties concerned. No additional payments shall be made to the Contractor for delays caused by utility interference due to negligence on the part of the Contractor. The Contractor shall support all utility lines uncovered due to excavation. The Town shall be held harmless for fines levied or costs incurred due to interruptions in service caused by the Contractor during the course of work.

10.00 SEPARATE CONTRACTS

10.01 The Engineer reserves the right to let other contracts in connection with this work. The Contractor shall afford other contractors reasonable opportunity for the introduction and storage of their materials and the execution of their work, and shall properly connect and coordinate his work with theirs.

10.02 Wherever work being done by the Town of Glastonbury's forces or by other contractors is contiguous to work covered by this Contract, the respective rights of the various interests involved shall be established by the Engineer to secure the completion of the various portions of the work in general harmony.

11.00 INSPECTION OF WORK

11.01 The Town shall provide sufficient personnel for the inspection of the work.

11.02 The Engineer shall at all times have access to the work whenever it is in preparation or progress, and the Contractor shall provide proper facilities for such access and for inspection.

11.03 If the specifications, the Engineer's instructions, laws, ordinances, or any public authority require any work to be specially tested or approved, the Contractor shall give the Engineer timely notice of its readiness for inspection and, if the inspection is by another authority other than the Engineer, of the date fixed for such inspection. Inspections by the Engineer shall be made promptly, and where practicable, at the source of supply. If any work should be covered up without approval or consent of the Engineer, it must, if required by the Engineer, be uncovered for examination and properly restored at the Contractor's expense.

11.04 Reinspection of any work may be ordered by the Engineer, and if so ordered, the work must be uncovered by the Contractor. If such work is found to be in accordance with the Contract Documents, the Town shall pay the cost of

reinspection and replacement. If such work is not in accordance with the Contract Documents, the Contractor shall pay such cost.

12.00 RIGHT TO INCREASE OR DECREASE WORK

12.01 The Town shall have the right to increase or decrease the amount of work herein specified as may be required.

13.00 RIGHT OF ENGINEER TO STOP WORK FOR WEATHER CONDITIONS

13.01 Should the work be carried on early or late in the year and, in the opinion of the Engineer is in danger by reason of inclemency of weather, or could not be finished in time to prevent such danger, the Contractor shall cease operations upon order of the Engineer, and shall not resume them until ordered to do so by the Engineer when the weather conditions are favorable. The time of suspension should not be considered in the winter months.

13.02 The Contractor shall, upon such orders, discontinue work, remove all materials or appliances for or in use upon the work, and place the streets in proper condition for use by the public during the time the work is suspended as herein provided, without cost to the Town.

14.00 STAKES AND MARKS

14.01 The Engineer shall set reference stakes or bench marks for the construction of the work. Such reference stakes or bench marks shall be preserved by the Contractor until permission has been given by the Engineer to remove them.

14.02 The Contractor shall carefully preserve bench marks, reference marks, and stakes, and in case of willful or careless destruction, he shall be charged with the resulting expense in replacement and shall be responsible for any mistakes that may be caused by their unnecessary loss or disturbance.

15.00 CONTRACTOR TO BE RESPONSIBLE FOR IMPERFECT WORK OR MATERIALS

15.01 Any faithful work or imperfect material which may be discovered before the acceptance and the payment of the work shall be corrected upon the order of the Engineer. The inspection of the work does not in any manner relieve the Contractor of his obligation to construct work in the proper manner and the use of materials herein specified.

16.00 TOWN MAY NOTIFY CONTRACTOR IF WORK IS NOT CARRIED ON SATISFACTORILY

16.01 If, in the opinion of the Engineer, the Contractor is not proceeding with the work at a sufficient rate of progress so as to finish in the time specified, or has abandoned said work, or is not complying with the terms and stipulations or the Contract and specifications, the Engineer may serve notice on the Contractor to adopt such methods as will ensure the completion of the work in the time

specified, or in compliance with the terms and stipulation of the Contract and specifications.

16.02 If, within five (5) days after the Engineer has notified the Contractor that his work is not being carried on satisfactorily as before mentioned, the Engineer shall have the right to annul the Contract and manage the work under the direction of the Engineer, or re-let, for the very best interest of the Town as a new contract, the work under said new Contract shall be considered the responsibility of the defaulting Contractor.

16.03 Additional costs incurred over and above the original Contract shall be borne by the performance bond.

17.00 DEDUCTIONS FOR UNCORRECTED WORK

17.01 If the Engineer deems it inexpedient to correct work that has been damaged or that was not done in accordance with the Contract, an equitable deduction from the Contract price shall be made therefor.

17.02 The Contractor shall promptly remove from the premises all materials condemned by the Engineer as failing to meet Contract requirements, whether incorporated in the work or not, and the Contractor shall promptly replace and re-execute his own work in accordance with the Contract and without expense to the Town, and shall bear the expense of making good all work by other contractors destroyed or damaged by such removal or replacement.

17.03 If the Contractor does not remove such condemned work and materials as promptly as possible after written notice, the Engineer may remove them and store the materials at the expense of the Contractor.

18.00 CLEANING UP

18.01 The Contractor must remove all debris of every description as the work progresses and leave the surroundings in a neat and orderly condition to the satisfaction of the Engineer.

18.02 Upon completion, and before acceptance and final payment, the Contractor shall remove from the site all equipment, forms, surplus material, rubbish and miscellaneous debris and leave the site in a neat and presentable condition.

19.00 ROYALTIES AND PATENTS

19.01 The Contractor shall pay all royalties and license fees. He shall defend all suits or claims for infringement of any patent rights and shall save the Town of Glastonbury harmless from loss on account thereof, except that the Town of Glastonbury shall be responsible for all such loss when a particular manufacturer, product, or process is specified by the Town of Glastonbury.

01.00 NOTICE TO CONTRACTOR

01.01 The Contractor is hereby alerted to the fact that the State of Connecticut Department of Transportation Standard Specifications for Roads, Bridges and Incidental Construction, Form 816 (Form 816) and supplements thereto are to be considered part of the Contract Documents. The Form 816 shall not be provided by the Town and any cost associated therewith shall be the responsibility of the Contractor. In case of any discrepancy between the Contract Drawings or Specifications and the Form 816, the matter shall immediately be submitted to the Engineer. The Engineer shall have sole authority in resolving any discrepancies.

01.02 Sections of sidewalk to be repaired are generally grouped together by the Town whenever possible to allow for a full load of concrete to be utilized. However, short load fees from concrete suppliers may be required on occasion for the completion of the work, and shall be the responsibility of the Contractor at no additional expense to the Town.

01.03 The Town performs sidewalk repair and replacement work in sections as the work becomes necessary throughout the duration of the Contract period. Contractors who bid this work shall expect to mobilize to the Town on multiple occasions throughout the Contract period.

01.04 The Contractor shall mobilize to the designated sidewalk construction site within fourteen (14) calendar days of notice being given by the Town. Failure to meet this requirement will be considered just cause for termination of the Contract.

02.00 BASIS OF AWARD

02.01 It is the intention of the Town to award one contract for pay items 1 through 14, and one contract for pay item 15. However, the Town reserves the right to award, accept or reject by individual item(s) when deemed to be in the best interest of the Town. The Town also reserves the right to award this bid to multiple vendors based on the types of repairs to be completed or anticipated to be completed during the time period specified. The awards for this bid will be based on anticipated work and available funding.

03.00 CONTRACT DURATION AND ESTIMATED VALUE

03.01 This Contract shall be effective through December 31, 2013. The Town reserves the right to extend this Contract, or portions of this Contract, for an additional one year period upon written agreement between the Town and Vendor.

03.02 The estimated total value of sidewalk repair or replacement is \$60,000.

04.00 MAINTENANCE / GUARANTEE PERIOD

04.01 The Contractor shall be held responsible to the Town for maintenance for a minimum of one-year following completion of all work under this Contract with respect to defects, settlements, etc.

05.00 DISPOSAL AREA

05.01 The Tryon Street Bulky Waste Facility will be available to the Contractor, at no charge, for disposal of materials that are accepted at that facility. Acceptable materials include brush, stumps, demolition materials, and excess excavated earth materials. Unacceptable materials are hazardous wastes such as pesticides, oil based paints and thinners, or other wastes as designated by the State Department of Environmental Protection. Demolition material cannot contain asbestos or other hazardous materials. The Contractor is required to obtain a disposal area for all other unsuitable or surplus materials at no cost to the Town.

**INDEX OF
DETAILED CONSTRUCTION SPECIFICATIONS**

<u>SECTION</u>	<u>DESCRIPTION</u>	<u>PAGE</u>
201.0	CONCRETE SIDEWALKS	2
204.0	GRADING AND TOPSOIL.....	7
205.0	TURF ESTABLISHMENT	8
206.0	SEDIMENTATION CONTROL SYSTEM.....	10
207.0	SEDIMENTATION CONTROL SACK.....	11
213.0	EARTHWORK AND GRADING FOR SIDEWALK CONSTRUCTION	12
214.0	BASE COURSE UNDERNEATH SIDEWALKS	13
215.0	PERMANENT DRIVEWAY REPAIRS	14
226.0	SIDEWALK RAISING	15
228.0	TREE ROOT PRUNING AND ROOT BARRIER INSTALLATION	17

INDEX OF CONSTRUCTION DETAILS

	<u>TITLE</u>	<u>PAGE</u>
1.	CONCRETE SIDEWALK DETAIL	5
2.	CONCRETE SIDEWALK RAMP DETAIL.....	6

201.0 CONCRETE SIDEWALKS

201.1 General: The Contractor is to construct sidewalks to lines and grades as shown on the drawings or at locations as directed by the Engineer. The sidewalks shall be of monolithic construction and five inches thick, except at industrial and commercial driveways where it shall be eight inches thick and reinforced with 6" x 6" 10/10 steel mesh. Sidewalk construction shall include the removal of existing and construction of new house lateral walks where new sidewalk grades make it necessary. At street corners where the intersection is rounded with a radius of less than 25 feet to the curb, the sidewalk slabs will be a minimum of five feet in length and constructed of five-inch thick concrete. The sidewalk shall pitch to the street at a slope of ¼-inch per foot or as directed by the Engineer.

Pedestrian sidewalk ramps are to be constructed to the lines and grades shown on the plans at locations directed by the Engineer, and shall be a minimum of five inches thick. This work shall also include furnishing and installing Detectable Warning Strips in the locations and to the dimensions and details shown on the plans or as ordered by the Engineer.

201.2 Forms: The forms used shall be five-inch steel or 2" x 6" wood firmly supported and staked to the line and grade given by the Engineer. The forms shall be free from warp and shall be of sufficient strength to resist springing out of shape. All forms shall be cleaned and oiled before use.

201.3 Concrete: The concrete furnished shall conform with respect to composition, transportation, mixing and placing, to Class F Cement Concrete 4,000 PSI, as specified by the State of Connecticut Department of Transportation in its latest specification and revisions. An approved air-entraining admixture shall be used to entrain 5% to 7% air in the concrete.

201.4 Detectable Warning Strips: The Detectable Warning Strip shall be a prefabricated detectable warning surface tile as manufactured from Engineered Plastics Inc. 300 International Drive, Suite 100 Williamsville, NY 14221, telephone number (800) 682-2525 or the approved equal from ADA Fabricators, INC. P.O Box 179 North Billerica, MA 01862 telephone number (978) 262-9900. The tile shall conform to the dimensions shown on the plans and have a brick red homogeneous color throughout in compliance with Federal Standard 595A Color #22144 or approved equal.

The Detectable Warning Strip shall be set directly in poured concrete according to the plans and the manufacturer's specifications or as directed by the Engineer. The Contractor shall place two 25 pound concrete blocks or sandbags on each tile to prevent the tile from floating after installation in wet concrete.

201.5 Dowels: Smooth metal dowels, 5/8-inch in diameter, measuring 24 inches in length shall be installed using plastic sleeves within all expansion and contraction joints, concrete driveway aprons, at concrete sidewalk ramps, and at the last end section of each sidewalk slab poured at the end of each working day.

Plastic sleeves of the size required for accepting the 5/8-inch by 24-inch smooth metal dowels shall be "Speed Dowel" sleeves as manufactured by Greenstreak, 3400 Tree Court Industrial Blvd, St. Louis, MO 63122, telephone number (800) 551-5145 or approved equal. Plastic sleeves shall be installed according to manufacturer instructions and as directed by the Engineer.

Dowels are also to be installed between new and existing concrete slabs. Where new or repaired walks abut up against existing concrete sidewalks, the Contractor shall drill two holes measuring $\frac{3}{4}$ -inches in diameter and 12 inches in depth into the existing concrete slab. The dowels, with plastic sleeve, shall be set into the existing sidewalk slab prior to the placement of concrete. The dowels are to be level with the latitude pitch of the sidewalk and shall conform to details of these specifications.

Smooth metal dowels shall be $\frac{5}{8}$ -inch in diameter and 24 inches in length. All metal dowels shall conform to the requirements of ASTM A615 Grade 60.

201.6 Expansion Joints: At maximum intervals of 15 feet, an expansion joint shall be placed to the full depth of the concrete slab. The material for expansion joints shall be either $\frac{1}{4}$ -inch thick cork asphalt or $\frac{3}{8}$ -inch thick asphalt impregnated bonded cellular fiber, or approved equal. Expansion joints of the same material shall also be placed at points abutting existing structures.

201.7 Surface Finish: The surface finish shall be struck off, forcing coarse aggregate below mortar surface. After strike-off, the surface shall be worked and floated with a wooded, aluminum, or magnesium float followed by steel troweling. The slab shall then be broomed cross-wise with a fine hair broom. The outside edges of the slab shall be edged with a $\frac{1}{4}$ -inch radius tool. All edging lines shall be removed.

201.8 Curing: The Contractor shall use a liquid membrane-forming curing compound. The curing compound shall be similar or equal to Demicon "Cure Hard" with fugitive dye and shall meet the latest ASTM Specification C-156. Waterproof paper or plastic membrane are acceptable alternatives.

Newly constructed sidewalk surfaces shall be protected from all foot or vehicular traffic for a period of seven days. The Contractor shall have on the job, at all times, sufficient polyethylene film or waterproof paper to provide complete coverage in the event of rain.

201.9 Temperature: No concrete is to be placed when air temperature is below 40°F, or at 45°F and falling, unless prior approval is given by the Engineer. In the event weather conditions may be such that concrete that is not completely cured is subject to freezing, the Contractor shall provide a minimum of a six-inch layer of hay, straw, or thermal blankets for protection. Any concrete laid during cold weather that is damaged by freezing shall be the responsibility of the Contractor and shall be replaced at his expense.

201.10 Basis of Payment: New concrete sidewalk of the thickness and reinforcement indicated shall be measured and paid for at the contract unit price per square foot for "**New 5-inch Concrete Sidewalk**" and "**New 8-inch Reinforced Concrete Sidewalk**" as contained in the Bid Proposal, which price shall include all work described in Section 201, as well as BASE COURSE UNDERNEATH SIDEWALKS as per Section 214.0, EARTHWORK AND GRADING FOR SIDEWALK CONSTRUCTION as per Section 213.0, and all other materials and all labor, tools, and equipment necessary for completion of the work.

For the pay item "**New 5-inch Concrete Sidewalk on Existing Base Course**", the basis of payment per square foot shall include all of the concrete work described under Section 201, however the process stone base course

underneath sidewalk shall be existing in-place material and shall not be installed by the Contractor.

New Pedestrian Ramps shall be measured and paid for as a unit at the contract unit price for each **“New Pedestrian Ramp”** as contained in the Bid Proposal, which price shall include the include BASE COURSE UNDERNEATH SIDEWALKS as per Section 214.0, EARTHWORK AND GRADING FOR SIDEWALK CONSTRUCTION as per Section 213.0, Detectable Warning Strip, and all other materials and all labor, tools, and equipment necessary for completion of the work.

For the pay items **“Replacement 5-inch Concrete Sidewalk”**, **“Replacement 8-inch Reinforced Concrete Sidewalk”**, **“Replacement Pedestrian Ramps”** and **“Remove Existing Bituminous Sidewalk and Replace with New 5-inch Concrete Sidewalk”**, the basis of payment per square foot shall include all the concrete work described under Section 201, as well as the removal and disposal of existing bituminous or concrete walks and ramps.

NOTES:

1. CONCRETE SHALL BE CONNDOT CLASS F, (4,000 PSI, 28 DAY STRENGTH).
2. FORMS ARE TO BE SET TRUE TO LINE AND GRADE ON WELL COMPACTED BASE. FORMS SHALL BE 5" STEEL OR 2"x6" LUMBER.
3. PROPER FINISHING PROCEDURES WILL BE FOLLOWED INCLUDING JOINTING, EDGING, AND BROOMING. A FINE BRISTLE BROOM SHOULD BE USED. ALL EDGING TOOL IMPRINTS SHOULD BE STEEL TROWELED PRIOR TO BROOMING.
4. CURING COMPOUND MAY BE REQUIRED AS DIRECTED BY THE ENGINEER.
5. CONTRACTOR SHALL TAKE ALL NECESSARY PRECAUTIONS TO PROTECT SURFACE FROM DAMAGE.
6. WALKS SHALL BE BACKFILLED AS SOON AS FORMS ARE REMOVED.
7. ALL CONCRETE SIDEWALK SLABS SHALL BE RECTANGULAR IN SHAPE. NO FIGURE L SLABS ARE TO BE CONSTRUCTED.
8. SIDEWALK SLABS SHOULD NOT EXCEED 5' IN WIDTH. IF SIDEWALK SLABS GREATER THAN 5' IN WIDTH ARE TO BE CONSTRUCTED, A LONGITUDINAL EXPANSION JOINT SHALL BE CONSTRUCTED TO FORM ACCEPTABLE SLABS.
9. INSERT METAL DOWELS AT ALL EXPANSION JOINTS, AT SIDEWALK RAMPS, AND AT THE LAST SLAB POURED AT THE END OF THE WORKING DAY. DOWELS SHALL ALSO BE INSTALLED BETWEEN NEW AND EXISTING CONCRETE SLABS.
10. EXPANSION JOINT SHALL BE 3/8" ASPHALT IMPREGNATED CELLULAR FIBER AND OF A DIMENSION EQUAL TO THE FULL SLAB DEPTH.

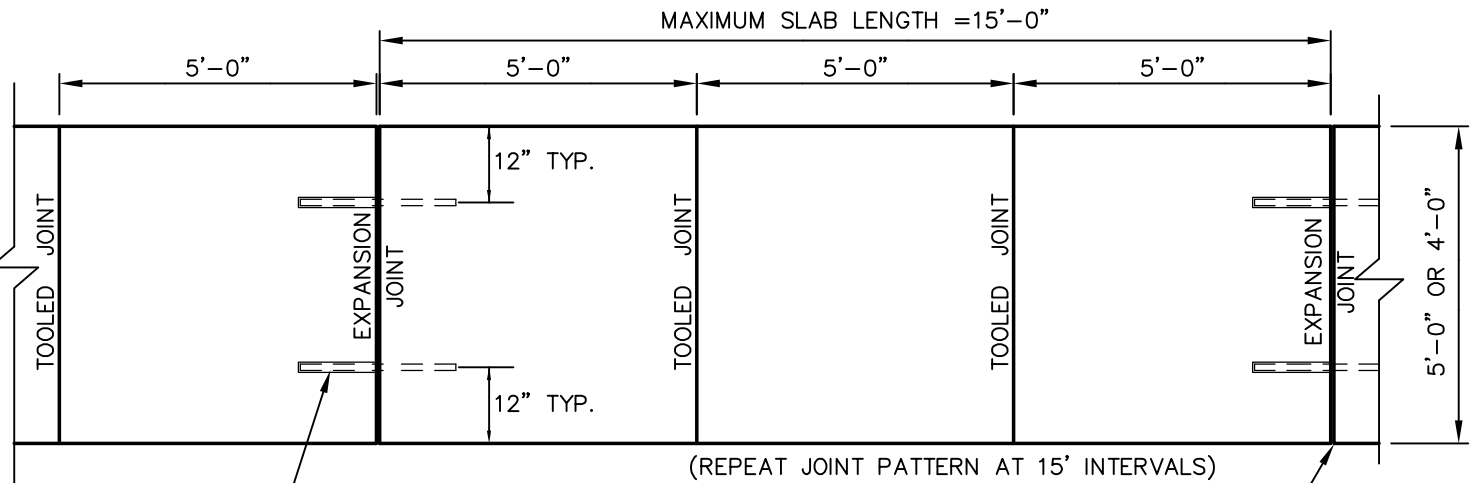

5/8" SMOOTH METAL DOWELS WITH "SPEED DOWEL" PLASTIC SLEEVE OR APPROVED EQUAL, SEE NOTE 9

SIDEWALK PLAN TYP.

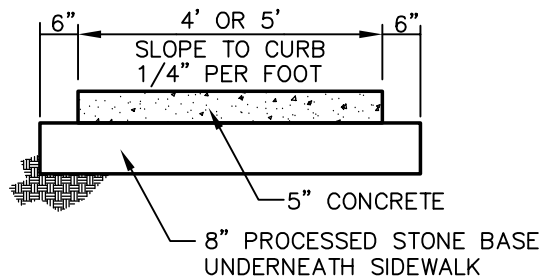

STANDARD SIDEWALK SECTION

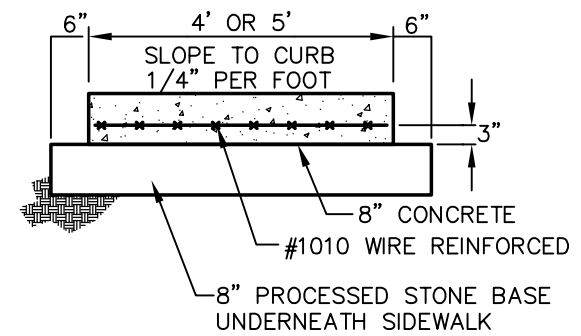

FOR INDUSTRIAL & COMMERCIAL AREAS ONLY DRIVEWAY SECTION

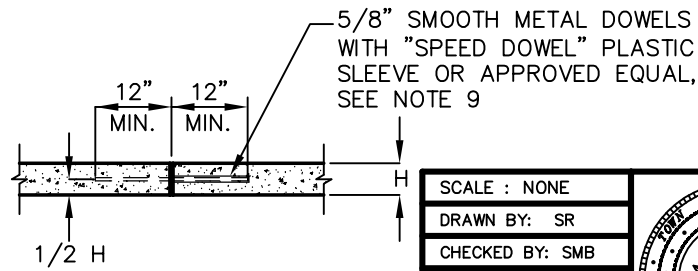

DOWEL DETAIL

SCALE : NONE
DRAWN BY: SR
CHECKED BY: SMB
APPROVED BY: DAP
LAST REVISED: 2/4/2011

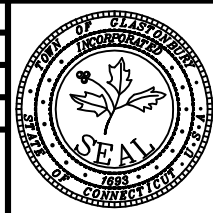

TOWN OF GLASTONBURY
 DEPARTMENT OF PHYSICAL SERVICES
 ENGINEERING DIVISION

CONCRETE SIDEWALKS

H:\DWG\Details\TOG\Standard Detail Plates\Plates6-Sidewalks.dwg



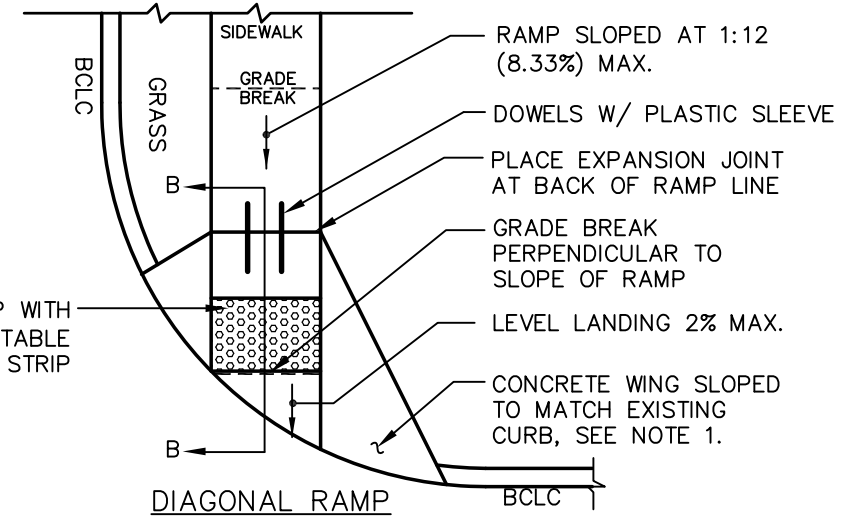
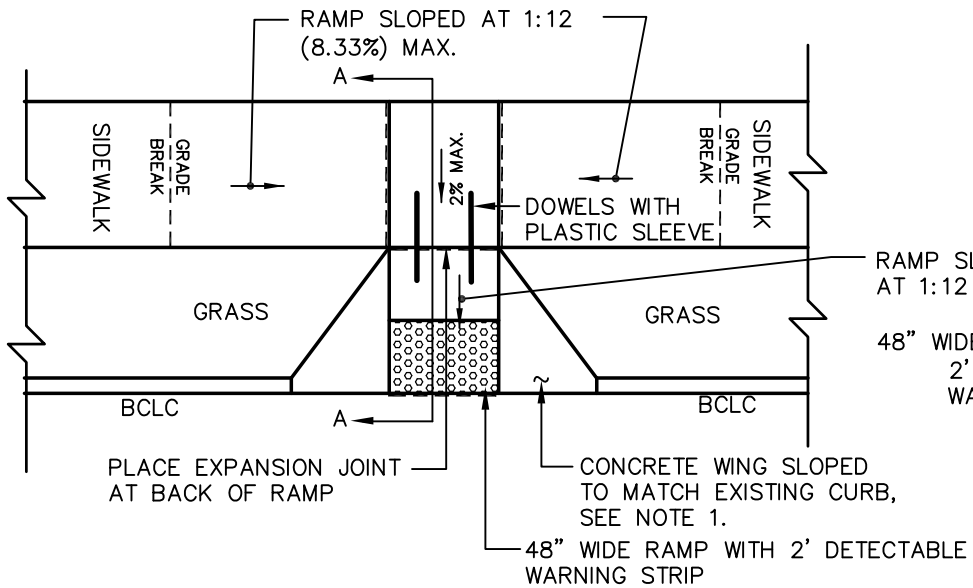

PERPENDICULAR RAMP

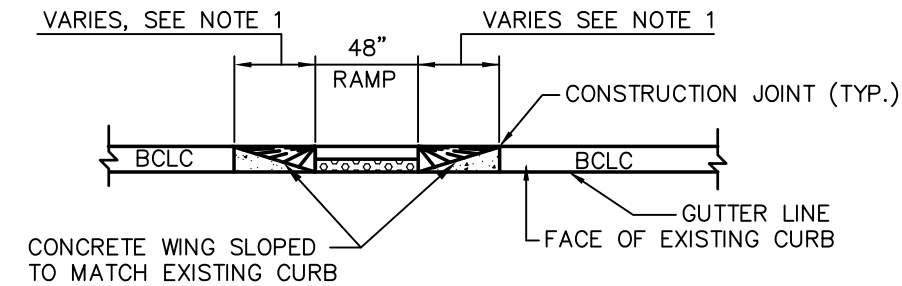

ELEVATION

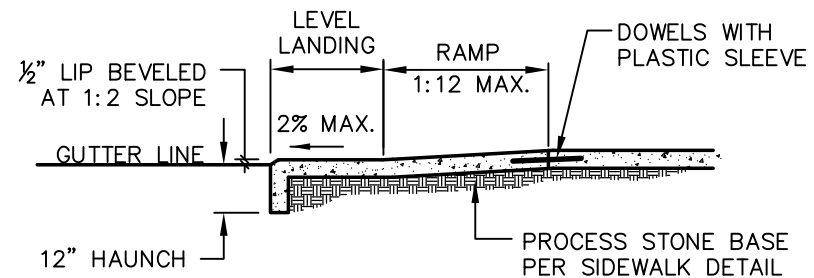

SECTION B-B

NOTES:

1. CONCRETE WING TO BE SLOPED AT 2 INCHES PER FOOT WHERE GRASS STRIP SEPARATES SIDEWALK FROM CURB. SLOPE WING AT 1 INCH PER FOOT WHERE SIDEWALK DIRECTLY ABUTS CURB, SEE CONNDOT STANDARD DETAILS FOR PARALLEL SIDEWALK RAMP (TYPE 1).
2. GRADE BREAKS AT ENDS OF 1:12 RAMP SHALL ALWAYS BE PERPENDICULAR TO SLOPE OF RAMP AND PARALLEL TO EACH OTHER.
3. DETECTABLE WARNING STRIP SHALL BE PREFABRICATED SURFACE TILE AS MANUFACTURED BY ENGINEERED PLASTICS INC., ADA FABRICATORS INC. OR APPROVED EQUAL. TILE SHALL BE BRICK RED IN COLOR.

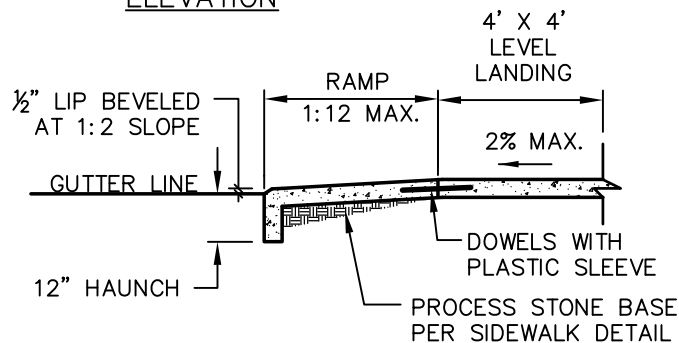

SECTION A-A

SCALE : NONE
DRAWN BY: SR
CHECKED BY: SMB
APPROVED BY: DAP
LAST REVISED: 1/26/2012

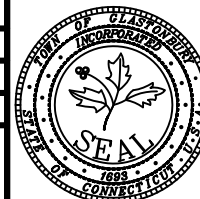

TOWN OF GLASTONBURY
 DEPARTMENT OF PHYSICAL SERVICES
 ENGINEERING DIVISION

CONCRETE SIDEWALK RAMPS

H:\DWG\Details\TOC\Standard Detail Plates\Plate7-Sidewalkramps-rev2012.dwg

204.0 GRADING AND TOPSOIL

204.1 Description: This work shall consist of furnishing, placing, and shaping topsoil in areas shown on the plans where directed by the Engineer. The topsoil shall be placed to the depth stated in the Contract or specifications.

204.2 Material: The material shall conform to the requirements of Article M.13.01.1 of the Form 816.

204.3 Construction Methods: The areas on which topsoil is to be placed shall be graded to a reasonably true surface and cleaned of all stones, brickbats, and other unsuitable materials. After areas have been brought to proper subgrade and approved by the Engineer or his agent, loam shall be spread to a depth as indicated in the Contract, or to a depth of no less than four inches, with due allowance made for settlement. All stones, roots, debris, sod, weeds, and other undesirable material shall be removed from the topsoil. After shaping and grading, all trucks and other equipment shall be excluded from the topsoiled area to prevent excessive compaction. The Contractor shall perform such work as required to provide a friable surface for seed germination and plant growth prior to seeding.

During hauling and spreading operations, the Contractor shall immediately remove any material dumped or spilled on the shoulders or pavement.

It shall be the Contractor's responsibility to restore to line, grade, and surface all eroded areas with approved material and to keep topsoiled areas in acceptable condition until the completion of the construction work.

Wherever subgrade material is sand, gravel, or other previous material, and elsewhere as required by the Engineer, the Contractor shall place a four-inch layer of clay or other impervious material on the subgrade material before placing loam.

204.4 Payment: This work will be measured for payment by the number of square yards of area on which the placing of the topsoil has been completed and the work accepted.

The limits of payment shall be to the slope limits as shown on the plans. In the absence of slope limits, the maximum area of measurement shall be the area extending two feet behind the sidewalk and the area between the sidewalk and edge of pavement. No payment shall be made outside of these limits unless the disturbance was directed or approved by the Engineer. No payment shall be made for areas disturbed for staging, storage of materials, or other area disturbed for the convenience of the Contractor.

This work will be paid for at the Contract unit price per square yard for "**Grading and Topsoil**" as listed in the Bid Proposal, which price shall include all materials, equipment, tools, labor, and work incidental thereto.

205.0 TURF ESTABLISHMENT

205.1 General: The work included in this item shall consist of providing an accepted uniform stand of established perennial turf grasses by furnishing and placing fertilizer, seed, and mulch on all areas to be treated as shown on the plans or where designated by the Engineer.

205.2 Materials: The materials for this work shall conform to the requirements of Section M.13 of the Form 816, except as noted below.

Seed mix for roadside areas shall consist of 70% Red Fescue, 20% Kentucky Blue Grass, and 10% Perennial Rye Grass or other mix for high maintenance lawn areas as approved by the Engineer.

Material certificates shall be provided for all materials supplied under this item.

205.3 Construction Methods: Construction Methods shall be those established as agronomically acceptable and feasible and which are approved by the Engineer.

1. Preparation of the Seedbed:

(a) Level areas, medians, interchanges and lawns: These areas shall be made friable and receptive for seeding by disking or by other approved methods to the satisfaction of the Engineer. In all cases the final prepared and seeded soil surface shall meet the lines and grades for such surface as shown in the plans, or as directed by the Engineer.

(b) Slope and Embankment Areas: These areas shall be made friable and receptive to seeding by approved methods which will not disrupt the line and grade of the slope surface. In no event will seeding be permitted on hard or crusted soil surface.

(c) All areas to be seeded shall be reasonably free from weeds taller than 3 inches. Removal of weed growth from the slope areas shall be by approved methods, including hand-mowing, which do not rut or scar the slope surface, or cause excessive disruption of the slope line or grade. Seeding on level areas shall not be permitted until substantially all weed growth is removed. Seeding on slope areas shall not be permitted without removal or cutting of weed growth except by written permission of the Engineer.

2. Seeding Season: The calendar dates for seeding shall be:

Spring—March 15 to June 15
Fall—August 15 to October 15

All disturbed soil areas shall be treated during the seeding seasons as follows:

(a) Areas at final grade: Seeding will be accomplished.

(b) "Out-of-season" seedings shall be performed in the same manner as "in-season" seedings. Since acceptable turf establishment is less likely, the Contractor shall be responsible for "in-season" reseeding until the turf stand conforms to this specification.

(c) During "out-of-season" periods unseeded areas shall be treated in accordance with Section 2.10, Water Pollution Control.

3. Seeding Methods: Seed mixture shall be applied by any agronomically acceptable procedure or through hydroseeding methods when directed by the Engineer. The rate of application of seed shall be no less than 175 pounds per acre or according to manufacturer instructions. Fertilizer conforming to M.13.03 shall be initially applied at a rate of 320 pounds per acre during or preceding seeding. When wood fiber mulch is used, it shall be applied in a water slurry at a rate of 2,000 pounds per acre with or immediately after the application of seed, fertilizer and limestone. When the grass seeding growth has attained a height of 6 inches, the specified areas designated herein shall be mowed to a height of 3 inches. Following mowing, all seeding grass areas (mowed and un-mowed) shall receive a uniform application of fertilizer hydraulically placed at the rate of 320 pounds per acre.

4. Compaction: The Contractor shall keep all equipment and vehicular and pedestrian traffic off areas that have been seeded to prevent excessive compaction and damage to young plants. Where such compaction has occurred, the Contractor shall rework the soil to make a suitable seedbed; then re-seed and mulch such areas with the full amounts of the specified materials, at no extra expense to the Town.

5. Stand of Perennial Turf Grasses: The Contractor shall provide and maintain a uniform stand of established turf grass having attained a height of 6 inches consisting of no less than 100 plants per square foot throughout the seeded areas until the entire project has been accepted.

6. Establishment: The Contractor shall keep all seeded areas free from weeds and debris, such as stones, cables, baling wire, and he shall mow at his own expense, on a one-time-only basis, all slopes 4:1 or less (flatter) and level turf established (seeded) areas to a height of 3 inches when the grass growth attains a height of 6 inches. Clean-up shall include, but not be limited to, the removal of all debris from the turf establishment operations on the shoulders, pavement, and/or elsewhere on adjacent properties publicly and privately owned.

205.4 Method of Measurement: This work will be measured for payment by the number of square yards of surface area of accepted established perennial turf grass as specified or by the number of square yards of seeding actually covered as specified.

Restoration of areas disturbed for staging, storage of materials, or other area disturbed for the convenience of the Contractor will not be measured for payment.

205.5 Basis of Payment: This work will be paid for at the contract unit price per square yard for "**Turf Establishment**" as listed in the Bid Proposal which price shall include all materials, mowing, maintenance, equipment, tools, labor, and work incidental thereto. Partial payment of up to 60% may be made for work completed, but not accepted.

206.0 SEDIMENTATION CONTROL SYSTEM

206.1 General: This item shall conform to Section 2.19 of the Form 816, with the following section replaced:

206.2 Basis of Payment (Section 2.19.05): Payment for this work will be made at the contract unit price per linear foot for "**Sedimentation Control System**" as listed in the Bid Proposal, complete in place, which price shall include all materials, equipment, tools and labor incidental to the installation, maintenance, replacement, removal and disposal of the system and surplus material. No payment shall be made for the clean out of accumulated sediment.

207.0 SEDIMENTATION CONTROL SACK

207.1 General: This work shall consist of furnishing, installing, maintaining, and removing a sedimentation control sack for control of sediment entering catch basins within the project area as directed by the Engineer or as shown on the contract drawings.

207.2 Materials: Sediment control sacks shall be Siltsack® as manufactured by SI® Geosolutions or approved equal, and shall be manufactured from a specially designed woven polypropylene geotextile.

The sediment control sack shall be manufactured to fit the opening of the catch basin or drop inlet to be protected. Sediment control sack shall have the following features: two dump straps attached at the bottom to facilitate emptying; lifting loops shall be included as an integral part of the system to be used to lift the sedimentation control sack from the basin; sediment control sack shall have a restraint cord approximately halfway up the sack to keep the sides away from the catch basin walls, this yellow cord is also a visual means of indicating when the sack should be emptied. Once the strap is covered with sediment, sediment control sack should be emptied, cleaned and placed back into the basin.

207.3 Construction Sequence: To install the sediment control sack in the catch basin, remove the grate and place the sack in the opening. Hold out approximately six inches of the sack outside the frame. This is the area of the lifting straps. Replace the grate to hold the sack in place.

When the restraint cord is no longer visible, the sediment control sack is full and should be emptied.

To remove the sediment control sack, take two pieces of 1" diameter rebar and place through the lifting loops on each side of the sack.

To empty the sediment control sack, place it where the contents will be collected. Place the rebar through the lift straps (connected to the bottom of the sack) and lift. This will turn the sedimentation control sack inside out and empty the contents. Clean out and rinse. Return the sedimentation control sack to its original shape and place back in the basin.

The sediment control sack is reusable. Once the construction cycle is complete, the sedimentation control sack shall be removed from the basin and cleaned. The sedimentation control sack shall then be provided to the Town for re-use.

207.4 Basis of Payment: This work shall be measured and paid for at the contract unit price for "**Sedimentation Control Sack**" as listed in the Bid Proposal for each sedimentation control sack provided, installed, and accepted by the Engineer

Maintenance of the sediment control sacks and cleaning after completion of construction as described herein shall also to be included in this bid price.

213.0 EARTHWORK AND GRADING FOR SIDEWALK CONSTRUCTION

213.1 General: The Contractor is to exercise caution to prevent unnecessary damage to lawns, trees, bushes, or any other existing improvements. If, in the opinion of the Engineer, existing improvements are damaged due to the carelessness of the Contractor, the same shall be repaired or replaced at the Contractor's expense.

213.2 Earthwork: The Contractor shall remove and dispose of grass, rubbish, and other objectionable materials within the limits of the sidewalk construction. The Contractor shall perform all excavation necessary to construct sidewalks to the grades as shown on the construction plans. Excavation shall include the saw cutting, removal, and disposal of bituminous concrete and concrete sidewalks, driveways, and pavements, including curbing and tree roots, where necessary, due to the new sidewalk grade and as shown on the plans or as directed by the Engineer. Existing house lateral walks and driveways adjacent to the sidewalk shall be removed and base graded and prepared for a smooth connection. The Contractor shall remove and dispose of all excess material.

213.3 Grading Existing Topsoil: Upon completion of sidewalk construction, the Contractor is to grade the areas between sidewalks and curbs, if the typical section indicates a grass plot, and disturbed areas back of the sidewalk. The Contractor shall backfill and compact these areas so as to conform to the typical cross-section. The upper four inches of the backfill shall be loam or topsoil, loose and friable and free of sticks, rocks, roots, weeds, or other unsuitable material.

213.4 Lawn Restoration: This work will consist of restoring grass areas disturbed in the Contract work. All work will be in conformance with Section 205.0 TURF ESTABLISHMENT.

213.5 Basis of Payment:
There will be no separate payment for this item. All of the above-described work under the heading "EARTHWORK AND GRADING FOR SIDEWALK CONSTRUCTION" shall be included in the contract unit price for concrete sidewalks.

The cost of removing a slab shall include the cost of equipment necessary to saw cut the appropriate joint which will allow the damage to be removed without disturbing the adjoining panel. This cost shall be included in the price for sidewalk replacement.

214.0 BASE COURSE UNDERNEATH SIDEWALKS

214.1 Description: The Contractor shall make the necessary excavation and furnish material for base construction under sidewalks.

214.2 Material: The material used for base course construction shall conform to the requirements of Section M.02.01 of the Form 816 for broken or crushed stone. It shall consist of sound, tough, and durable stone and shall be free of thin or elongated pieces, lumps of clay, soil, loam, or vegetative matter. All material shall be approved by the Engineer prior to its use. In making repairs to existing sidewalk the existing gravel base may be used with the Engineer's approval.

214.3 Construction Method: The material for the base course shall be spread upon the prepared subgrade to such depth as to give a compacted thickness of eight (8) inches. The material shall be uniformly spread in two (2) layers of equal depth in the entire base course excavation and each layer shall be wetted and compacted to a firm even surface with a roller weighing not less than 500 pounds or by use of pneumatic tampers or vibratory compactors.

214.4 Basis of Payment: There will be no separate payment for this item. All of the above-described work under the heading "BASE COURSE UNDERNEATH SIDEWALKS" shall be included in the contract unit prices for concrete sidewalks.

215.0 PERMANENT DRIVEWAY REPAIRS

215.1 Description: The Contractor shall furnish all labor, tools, material, and equipment to replace all driveway pavements damaged due to the sidewalk construction, as directed by the Engineer. This item shall also include the removal and disposal of existing bituminous pavement necessary for driveway replacement work, including sawcutting of existing pavement.

215.2 Materials:
The base course shall be processed stone of a quality satisfactory to the Engineer.

Hot laid bituminous concrete for driveway repairs shall be Bituminous Class 2 per Section M.04 of the Form 816.

215.3 Construction Methods: Portions of the driveway or driveway aprons to be replaced shall be saw cut, and the existing pavement removed and disposed of by the Contractor. The eight (8) inches of trench immediately below the bottom of the proposed pavement shall be backfilled with processed stone and compacted in two (2) layers of equal depth. The upper three inches shall be topped by the Contractor with hot bituminous concrete or as required to match the existing pavement, and maintained at grade. The edges shall be painted with an asphalt emulsion prior to the placement of permanent pavement. Hot laid bituminous concrete shall be placed so as to give a three (3) inch thick compacted surface, or a surface that has a depth equal to the existing driveway surface, whichever is greater. Compaction shall be made with a power-driven roller. The finished surface shall be free from waves or depressions.

215.4 Basis of Payment: Payment for this item will be made based on the contract unit price per square foot of "**Permanent Driveway Repairs**" as listed in the Bid Proposal, complete in place, which price shall include saw cutting, removal and disposal of existing bituminous pavement, all materials (including base materials), labor, tools, and equipment incidental thereto.

226.0 SIDEWALK RAISING

226.1 Description: Sidewalk Raising units shall include removal of temporary bituminous or mortar shims, layout, mudhole drilling, jacking, joint sawing (when required), hole plugging, panel blemish repair and clean-up, as required to level and repair sidewalk stones as marked in the field.

226.2 Materials:
Materials Dry Soil Mixture: The soil mixture used in the jacking material shall be composed of lime, sand, and ground clay. The dry material shall contain the following items in the following proportions:

Lime	35%
Sand	15%
Ground Clay	50%

Cement: Portland Cement to be used in mudjacking shall conform to AASHTO M85, as amended to date. Cement to be used in mudjacking shall be Type 1 Portland Cement.

Water: Water used shall be of drinkable quality and be supplied by the Contractor.

Panel Patching: Panel patching mortar shall be made with 3 parts Portland Type 1 Cement and 1 part mason sand.

Proportions:

Jacking Material: "Mud" for slabjacking shall be mixed with a proportion of cement to soil mixture not less than 1 to 7; sufficient water shall be added to provide a workable consistency. Once mixed, material shall be utilized within one hour after which, at the discretion of the Engineer, may be retempered by the addition and remixing of water.

Hole Patching: Hole patching mortar shall be made with 3 parts Portland Type 1 Cement and 1 part mason sand.

In lieu of the above mixtures, the Contractor may substitute alternate mixtures, subject to the approval of the Engineer.

226.3 Construction Methods:

Mudjack Holes: Holes shall be drilled by the Contractor by whatever means convenient to him. However, the Contractor shall exercise caution to prevent the cracking of the concrete slab in which the hole is being drilled. Any slab cracked due to drilling, excessive jack pressure, or tamping will be the responsibility of the Contractor and shall be replaced at his expense.

Jacking: Slabs shall be raised to the required elevation and pitched as directed by the Engineer. If required, sawcuts shall be made at sidewalk joints to allow free movement of the slab. Any sawcutting shall be included in the mudjacking price.

Patching Holes: Holes shall be cleaned the full depth of the slab by removing excess mud and wire brushing exposed sidewalks. Prior to placement of the Portland cement mortar, the whole surface shall be dampened with water.

Clean-Up: Walks mudjacked shall be thoroughly scraped and swept after completion, but prior to patching. Surrounding grass area disturbed due to the mudjacking shall be restored to its original state.

226.4

Basis of Payment:

Sidewalk raising will be measured per panel and will be paid for at the contract unit price for “**Sidewalk Raising**” per square foot as listed in the Bid Proposal, which price shall be full compensation for sawcutting, furnishing all material, labor, tools, equipment, and incidentals necessary to complete this work.

228.0 TREE ROOT PRUNING AND ROOT BARRIER INSTALLATION

228.1 Description: This work includes excavation of a tree protection trench adjacent to an existing or proposed sidewalk by means of a chain-driven trenching machine. This is performed within the drip line of an existing tree to cleanly sever roots prior to sidewalk excavation.

Also included in this item when called for by the Engineer is the installation of a tree root barrier system. This work includes use of a chain-driven trenching machine to sever tree roots and excavate the soil within the limits of the root barrier system, hand pruning of the roots using pruning shears, lopping shears, hand saws, and chain saws, as appropriate, and installation of an 18-inch deep tree root barrier.

228.2 Material: Tree root barrier shall be 18-inch deep polypropylene panels with integral molded stiffening ribs, root deflecting ribs, and panel joining system as manufactured by Deep Root Partners LP, Model UB 18-2, or approved equal.

228.3 Construction Methods: Tree protection trench or tree root barriers shall be installed in advance of the intended sidewalk construction during time periods where damage to trees will be minimized, as directed by the Engineer. The work area shall generally include the length of sidewalk within the drip line of the canopy of the tree of concern. Extreme care shall be taken by the Contractor to identify and protect underground utilities within the work area, and any conflicts shall be immediately brought to the attention of the Engineer.

Where tree protection trench is called for on the plans, the Contractor shall use a chain-driven trenching apparatus to sever tree roots adjacent to the sidewalk to the full depth of the sidewalk excavation as directed by the Engineer.

Where tree root barrier is called for on the plans, the contractor shall use the chain-driven trenching apparatus to sever tree roots and excavate the trench to a depth suitable for installation of the root barrier. Additional cutting of roots using hand methods may also be required, as directed by the Engineer. The tree root barrier shall then be installed according to the manufacturer's recommendations, including backfilling of the excavated trench. The disturbed area shall be restored to existing grades and shall be seeded per Section 205.00 of the specifications.

228.4 Basis of Payment:

Tree protection trench shall be measured for payment at the contract unit price per linear foot of "**Tree Protection Trench**" installed and accepted as listed in the Bid Proposal, which price shall include all materials, equipment, tools, labor, and work incidental thereto.

Tree root barrier shall be measured for payment for at the Contract unit price per linear foot for "**Tree Root Pruning and Barrier Installation**" as listed in the Bid Proposal, which price shall include materials, equipment, tools, labor, and work incidental thereto.

Restoration of disturbed areas shall be measured and paid for under Section 205.0 TURF ESTABLISHMENT.

Proposal of _____
(hereinafter called "Bidder"), organized and existing under the laws of the State of _____
_____, doing business as _____
_____.

To the Town of Glastonbury (hereinafter called "Town").

In compliance with your Invitation to Bid, the Bidder hereby proposed to furnish materials and/or services as per Bid Number GL-2013-25 in strict accordance with the Bid Documents, within the time set forth therein, and at the prices stated below.

By submission of this bid, the Bidder certifies, and in the case of a joint bid each party thereto certifies as to their own organization that this bid has been arrived at independently without consultation, communication, or agreement as to any matter relating to this bid with any other Bidder or with any competitor.

The Bidder acknowledges receipt of the following:

Addendum #1 _____

Addendum #2 _____

Addendum #3 _____

It is the responsibility of the Bidder to check the Town's website for any Addendum before submitting the bid.

**ANNUAL SIDEWALK PROGRAM
 BID PROPOSAL**

BID #GL-2013-25

ITEM NO.	DESCRIPTION	QTY.	UNIT PRICE
1.	New 5-inch Concrete Sidewalk as per Section 201.0 of the Detailed Construction Specifications	1 S.F.	\$_____/S.F.
2.	New 5-inch Concrete Sidewalk on Existing Base Course , as per Section 201.0 of the Detailed Construction Specifications	1 S.F.	\$_____/S.F.
3.	New 8-inch Reinforced Concrete Sidewalk as per Section 201.0 of the Detailed Construction Specifications	1 S.F.	\$_____/S.F.
4.	Replacement 5-inch Concrete Sidewalk as per Section 201.0 of the Detailed Construction Specifications	1 S.F.	\$_____/S.F.
5.	Replacement 8-inch Reinforced Concrete Sidewalk as per Section 201.0 of the Detailed Construction Specifications	1 S.F.	\$_____/S.F.
6.	New Pedestrian Ramp as per Section 201.0 of the Detailed Construction Specifications	1 EA.	\$_____/EA.
7.	Replacement Pedestrian Ramp as per Section 201.0 of the Detailed Construction Specifications	1 EA.	\$_____/EA.
8.	Grading and Topsoil as per Section 204.0 of the Detailed Construction Specifications	1 S.Y.	\$_____/S.Y.
9.	Turf Establishment as per Section 205.0 of the Detailed Construction Specifications	1 S.Y.	\$_____/S.Y.
10.	Sedimentation Control System as per Section 206.0 of the Detailed Construction Specifications	1 LF	\$_____/L.F.
11.	Sedimentation Control Sack as per Section 207.0 of the Detailed Construction Specifications	1 EA	\$_____/EA
12.	Permanent Driveway Repairs as per Section 215.0 of the Detailed Construction Specifications	1 S.F.	\$_____/S.F.

**ANNUAL SIDEWALK PROGRAM
 BID PROPOSAL**

BID #GL-2013-25

ITEM NO.	DESCRIPTION	QTY.	UNIT PRICE
13.	Tree Protection Trench as per Section 228.0 of the Detailed Construction Specifications	1 L.F.	\$_____/L.F.
14.	Tree Root Pruning and Barrier Installation as per Section 228.0 of the Detailed Construction Specifications	1 L.F.	\$_____/L.F.
15.	Sidewalk Raising as per Section 226.0 of the Detailed Construction Specifications	1 S.F.	\$_____/S.F.

The Bidder is directed to insert the words "NO BID" for each item of the Bid Proposal that contains work that the Bidder does not wish to perform.

**TOWN OF GLASTONBURY
 BID / PROPOSAL**

DATE ADVERTISED

2/25/2013

GL # or RPGL #

DATE / TIME DUE

2013-25

3/12/2013 at

11:00am

NAME OF PROJECT

Annual Sidewalk Program

It is the responsibility of the Bidder to clearly mark the outside of the bid envelope with the Bid Number, Date and Time of Bid Opening, and also THE RESPONSIBILITY OF THE BIDDER TO CHECK THE TOWN'S WEBSITE BEFORE SUBMITTING BID FOR ADDENDUMS POSTED PRIOR TO BID OPENING.

CODE OF ETHICS:

I/We have reviewed a copy of the Town of Glastonbury's Code of Ethics and agree to submit a Consultant Acknowledgement Form if I/We are selected. Yes _____ No _____*

*Bidder is advised that effective August 1, 2003, the Town of Glastonbury cannot consider any bid or proposal where the Bidder has not agreed to the above statement.

Respectfully submitted:

Type or Print Name of Individual

Doing Business as (Trade Name)

Signature of Individual

Street Address

Title

City, State, Zip Code

Date

Telephone Number/Fax Number

E-Mail Address

SS# or TIN#

(Seal – If bid is by a Corporation)

Attest